

WINE 32 / 45 / 185 FG

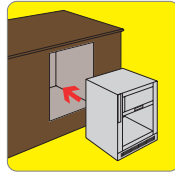

Wine 32 FG



Wine 45 FG





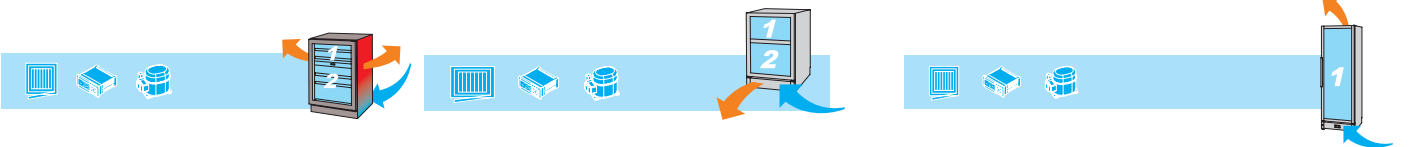
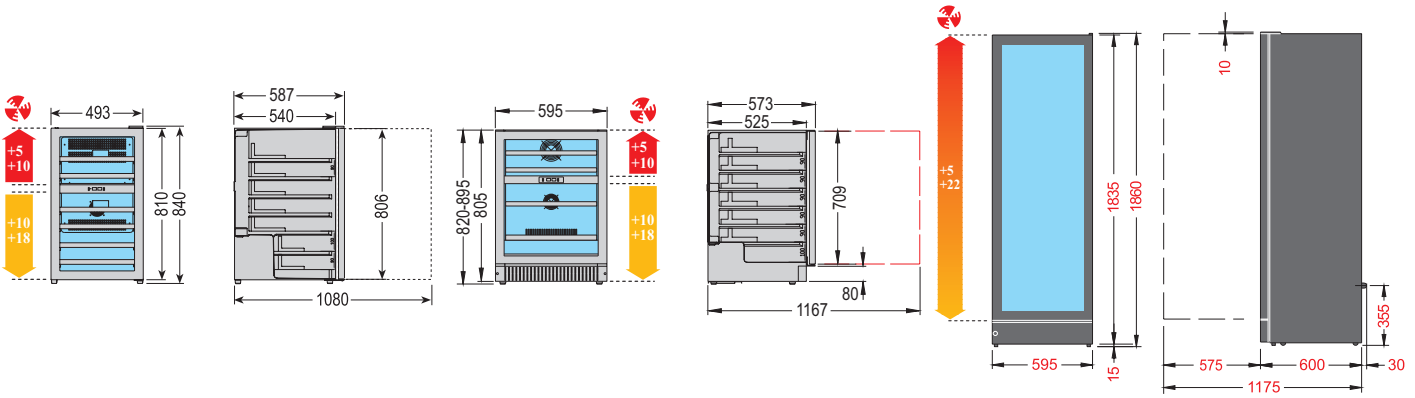









Wine 185 FG



Steckerfertig mit Kompressor	Wine 32 FG	Wine 45 FG	Wine 185 FG	Avec compresseur
Weinkühlschrank R600a Umluft Typen-Bezeichnung	Wine-32-FG	Wine-45-FG	Wine-185-FG	Armoire à vin de réfrigération R600a ventilée Indication
Vorgezogene Recyclinggebühr vRG netto				Taxe anticipée de recyclage TAR net
Transport CODE netto				CODE Transport net

WINE 32 / 45 / 185 FG

Ausführung	Wine 32 FG	Wine 45 FG	Wine 185 FG	Exécution
Temperaturbereich 	+5°/+10° C +10°/+18° C	+5°/+10° C +10°/+18° C	+5°/+22° C	Plage de température 
Temperaturzonen	2	2	1	Zones de température
Aufstellart eingebaut		✓		Mode d'installation intégré
Aufstellart freistehend		✓		Mode d'installation en pose libre
Umluft mit Luftleitblech 		✓		Ventilation a. plaque de diffusion d'air 
Aussenmasse: BxTxH (mm)	493 x 587 x 840	595 x 573 x 820/895	595 x 630 x 1860	Dimensions extérieures: LxPxH (mm)
Aussen / Material	schwarz / Vollglas noir / Verre plein			Extérieur / Matériau
Innenausführung	dunkel / foncé			Aménagement intérieur
Rauminhalt brutto (l)	106	145	368	Volume brut (l)
Gewicht brutto (kg) 	40	51	87	Poids brut (kg) 
Energieeffizienzklasse	G 	G 	G 	Classe d'efficacité énergétique
Energieverbrauch, kWh/Jahr (AEC)	142	145	175	Consommation électr., kWh/année (AEC)
Klimaklasse	4	4	4	Classe climatique
Kältemittel	R600a GWP 3 0,03 kg	R600a GWP 3 0,035 kg	R600a GWP 3 0,079 kg	Réfrigérant
Elektroanschluss	230 V / 50 Hz			Branchement
Anschlussleistung (Watt)	100	125	170	Puissance totale absorbée (watt)
Digitalsteuerung mit Temperaturanzeige		✓		Commande digitale avec affichage de température
Automatische Abtauung und Tauwasserverdunstung		✓		Dégivrage automatique et évaporation d'eau de dégivrage
Anzahl Flaschen 0.75 l max.	32	45	191	Nombre de bouteilles 0.75 l max.
Holzroste	4 (413x423mm)	4 (523x423mm)	4 (520x440mm)	Grilles en bois
Holzroste	2 (413x290mm)	1 (523x290mm)	1 (520x360mm)	Grilles en bois
Holzroste			1 (520x230mm)	Grilles en bois
Glastür rechts gebandet, umbandbar ab Werk		✓		Porte en verre à charnières à droite, réversible départ usine
mit Schloss 	-	✓	✓	avec serrure 
Integrierte LED-Beleuchtung 		✓		Eclairage LED intégré 
Magnetsichtung auswechselbar		✓		Joint magnétique changeable
Geräuscheniveau -dB (A)		39		Niveau de bruit -dB (A)

Kostenanteil Arbeitsaufwand

Art. Nr.

Participation aux frais de travail

Band links Glastür

UM-G-TUERE

Charnière à gauche porte vitrée



Interner Aktivkohlefilter, der unangenehme Gerüche beseitigt
Filtre à charbon actif interne qui élimine les odeurs désagréables.



1 Gitterschrägrost 45°
Grille inclinée à 45°

Farbe standard
Standard color



COD. 13